

GMC
TRUCK

SONOMA

1991



GMC TRUCK
It's not just a truck anymore..



Stylish tailgate applique identifies Sonoma SLE models



Club Coupe models offer available rear jump seats



MAKES YOU KING OF YOUR HILL



High-contrast instrument panel graphics enhance the clarity of gages for both night and day driving

SONOMA: A PICKUP AT THE TOP OF ITS CLASS. If you demand the highest quality standards in a compact pickup, Sonoma is for you. Check its outstanding credentials...then drive one at your local GMC Truck dealer. See why it makes you "King of your hill."

The leading edge in design. It's the best-looking compact pickup in GMC Truck history. Three smart models: SLE, SLS and SL. Each has a distinctive appearance inside and out.

Most powerful V6 in a compact truck. The 4.3 Liter Vortec V6 with Electronic Fuel Injection and advanced valve train features offers more V6 power than any non-GM compact truck. It's standard on Sonoma 4x4s and available on 4x2 models.

4x4 Sonoma SLE Club Coupe Pickup shown with available equipment



Sliding rear window is available

More towing muscle than most non-GM compact pickups — up to 6000 lb gross trailer weight for 4x2 models when properly equipped (weight includes trailer, its equipment and everything in it). See page 17 for a list of more standard value equipment and features.

SLE: EQUIPPED LIKE NO OTHER SONOMA. The distinction begins with a high-style chromed grille with dark gray air intake area. To this we add: Dark gray body side moldings with bright trim Bright wheel opening moldings Dark gray front bumper with bright-trimmed rub strip Rally wheels with bright trim rings (4x2 models).

And that's only part of the story. For details of the luxurious SLE interior, see page 8. A list of standard equipment common to all models can be found on pages 14, 15 and 17.

INDEX	PAGE
Model Choices	2-7
Interiors	8-9
4x4 Features	10-11
Trailering/Powerteams	12
Trim Levels/Colors	13
Quality Features	14-15
Available Equipment/ Quick Order EZ-Specs	16
Standard & Available Equipment By Model	17
Model Selector/ Exterior Dimensions	18
Technical Information/ Owner Benefits	19
Warranty	19



Manually-operated sunroof with deep-tinted glass is available



Below-eyeline outside rearview mirrors are available



4x2 Sonoma SLS Regular Cab Pickup with 7.4-ft cargo box. Shown with available equipment.



THE WINNING SPIRIT FOR YOUR LIFESTYLE

DESIGNED TO TURN HEADS WHEREVER YOU GO. Sonoma SLS combines excitement and sporty styling with the crisp handling and smooth ride that marks it as a first-class personal pickup. For the exterior you can choose from five brilliant solid paint colors: Midnight Black, Apple Red, Frost White, Aspen Blue Metallic or Seafoam Green. The street-smart exterior also features:

- Red lower body striping with Sonoma ST letter-

- ing on front door and tailgate
- Body color grille
- Body color front bumper with red decal stripe
- Dark gray styled wheels with red striping (4x2 models)
- Black taillamp trim.

Interior trim and color selections are described on page 9; color on page 13. Standard features common to all models are listed on pages 14, 15 and 17.

Enjoy the luxury of extra space with a Club Coupe model that provides 18.4 cu ft of lockable space behind the standard 3-passenger front seat. Club Coupe also can be equipped to carry four passengers by ordering available reclining front bucket seats and folding rear jump seats.



4x4 SLS Club Coupe shown with available equipment



Full-feature AM stereo/FM stereo radio is available *



Tilt steering wheel is available as part of a convenience package



Rearview mirror with reading lamps is available as part of a lighting package

*Receives C-QUAM® AM stereo broadcasts. Most AM stereo stations across the country broadcast in C-QUAM, but some do not. Check with your local stations for compatibility in your area.

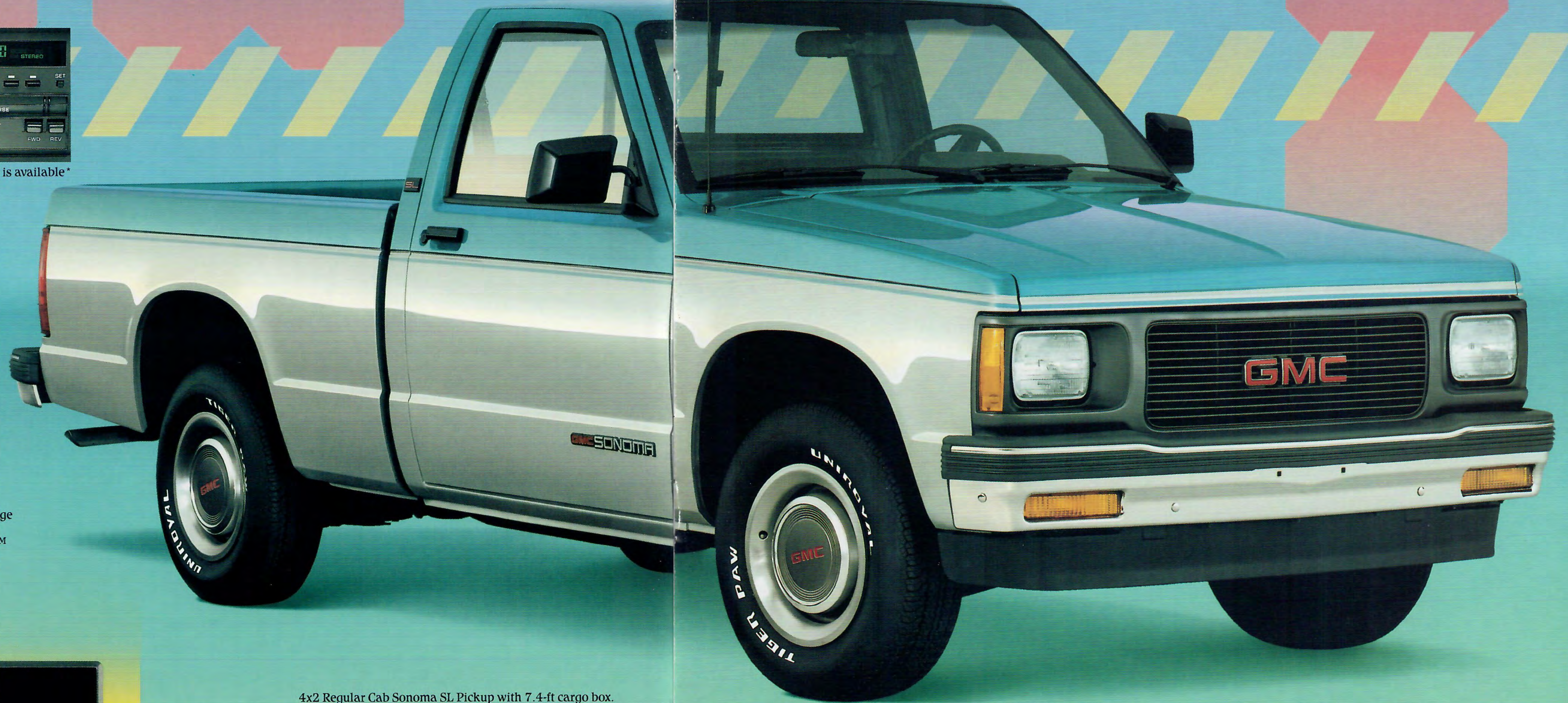

4x2 Regular Cab Sonoma SL Pickup with 7.4-ft cargo box. Shown with available equipment.



A TRUCKLOAD OF AMERICAN STANDARD VALUE

SL DELIVERS THE RIGHT STUFF AT A GREAT PRICE. It looks sharp. It works hard. It carries you in comfort. That's a combination that's pretty tough to beat. Especially when you consider all that's included in SL's affordable price:

- New higher-output 2.5 Liter Tech IV power with Electronic Fuel Injection (4x2 models)
- 4.3 Liter Vortec V6 with Electronic Fuel Injection (4x4 models)
- 5-speed manual transmission with overdrive
- Power steering and tow hooks on 4x4 models
- Power front disc/rear drum brakes
- Rear wheel anti-lock brake system (operates only in 2-WD on 4x4 models)
- All Season steel-belted, radial-ply tires
- Front stabilizer bar
- Tinted window glass

all around Instrument gage package Electronically-tuned AM/FM stereo radio with seek-scan, digital clock and premium rear speakers. (The preceding items also are included with SLE and SLS models, but not all are standard on the X81 "Special" Regular Cab model. See your GMC Truck dealer for details.)

The handsome SL exterior treatment includes halogen-type headlamps and sporty dark gray grille, front bumper and wheels. Ten solid paint color choices are available as standard equipment. Inside, SL comes with flow-through power ventilation, cigarette lighter, day/night rearview mirror, deluxe heater with side window defoggers, dome and courtesy

lamps, parcel tray, lockable glove box and full length insulated headliner. Like all Sonomas, it also comes with Commitment Plus delivery (see page 19). For information on interior trim and color selections, see page 9.

For special needs, a value-priced 4x2 Regular Cab Sonoma Special model (X81) is available. Ask your GMC Truck dealer for details.



4x2 Sonoma SL Pickup with available equipment



A



B



C

SLIP INTO SOMETHING COMFORTABLE

CAB INTERIORS THAT LOOK GOOD AND FEEL GOOD. Sonoma offers a selection of three distinctive interior treatments in color choices of Blue, Garnet, Charcoal or Saddle. Three-person front bench seating is standard.

A Sonoma SLE. The ultimate in Sonoma elegance, SLE's richly appointed interiors offer a choice of Custom Vinyl or Custom Cloth trim for bench seats.

Available high-back bucket seating (reclining type on Club Coupes) can be ordered in Custom Vinyl or new Special Custom Cloth trim (shown); Club Coupe models also offer velour cloth trim with leather inserts in Charcoal or Saddle colors only. Color-keyed appointments include floor carpeting, trim panels, headliner and dual sun shades. Door trim panels have storage pockets, cloth inserts and carpeted lower trim.

B Sonoma SLS. With this sporty trim, there's a choice of Custom Vinyl or Custom Cloth bench seat upholstery. Available high-back bucket seats (reclining type for Club Coupe models) can be ordered in Custom Vinyl for all models and also in new Special Custom Cloth (shown). Color-keyed floor carpeting and headliner add to the luxurious decor.

C Sonoma SL. This handsome standard trim offers bench seating in your choice of Custom Vinyl or Custom Cloth (shown), or available high-back bucket seats (reclining type for Club Coupe models) in Custom Vinyl. All interior trim items, except the floor mat, are color-coordinated for smart appearance.



Power door lock/power window combination is available



4x4

WITH INSTA-TRAC

AN EARTH-GRIPPING 4x4 ADVENTURE

4x4 Sonoma SLE Club Coupe Pickup shown with available equipment

INSTA-TRAC: ONE OF THE MOST ADVANCED 4x4 SYSTEMS ON THE ROAD...OR OFF. That's because Insta-Trac makes it a cinch to get all four wheels gripping the ground when you want added traction. This GM-patented system eliminates the need to stop and get out to lock or unlock hubs. With a quick flick of a lever, you shift the transfer case from 2 WHEEL to 4 HIGH at any speed. The return to free-wheeling 2-WD is just as easy. Just shift, without stopping or slowing down. Other easy-driving features include power brakes and power steering. A

rear wheel anti-lock brake system also is standard (operates only in the 2-WD mode). A road-hugging torsion bar independent front suspension soaks up the bumps and provides good tire-to-ground contact for traction and stability.

All Sonoma 4x4 models feature the trailblazing performance of the 4.3 Liter Vortec V6, the most powerful V6 in the compact pickup field. It generates impressive horsepower and torque for climbing hills or cruising through rough terrain.

A 5-speed manual transmission with overdrive is standard. Or choose the available 4-speed automatic transmission with overdrive.

Choose from Regular Cab or Club Coupe body styles with SL, SLS or SLE trim. There's loads of space for freight in a big 7.4-ft (Regular Cabs only) or 6.1-ft cargo box. For added stability and riding quality off-road, there's an available suspension package which includes Delco/Bilstein gas-charged shock absorbers, heavy-duty torsion bars, special jounce bumpers and special stabilizer bar.

Before traveling off-road with your Sonoma 4x4 ask your dealer for a copy of "Off-Road Driving With Your GMC Truck 4x4". This booklet is filled with helpful tips and facts. If your dealer doesn't have a copy, please call 1-800-TRY GMC 1.





HUSTLE AND MUSCLE FOR TRAILERING

SONOMA MOVES UP TO 9500 LBS. A properly equipped 4x2 Sonoma with available 4.3 Liter Vortec V6 engine can move a gross combination weight of up to 9500 lbs (see adjacent chart). Special factory-installed equipment is available to outfit Sonoma for trailering. For details about trailering recommendations and requirements, ask your GMC Truck dealer for a copy of the 1991 Trailering Guide.

GROSS COMBINATION WEIGHT RATING (GCWR) (1)

Engine	GCWR (lb) BY ENGINE AND AXLE RATIO								
	4500	5000	5500	6000	6500	7500	8000	8500	9500
Axle Ratio With Automatic Transmission									
2.5L Tech IV			3.73	4.11					
4.3L Vortec V6								3.08 (2)	3.42 (2)
Axle Ratio With Manual Transmission									
2.5L Tech IV		3.73	4.11						
2.8L V6	3.42	3.73							
4.3L Vortec V6						3.08 (3)	3.42 (3)		

1 - Includes tow vehicle, trailer, passengers, cargo and equipment on tow vehicle and trailer.
 2 - Above GCWR reduced by 1000 lb if tow vehicle is equipped with available P235/75R15 tires.
 3 - Above GCWR reduced by 500 lb if tow vehicle is equipped with available P235/75R15 tires.

GET UP AND GO WITH SONOMA

SPORTY PERFORMANCE RUNS IN THE FAMILY. Every Sonoma Pickup gives you the power of high-tech efficiency. That means advanced standard features like Electronic Fuel Injection for quick starts and smooth, responsive performance. Plus, an efficient single-belt accessory drive system (instead of conventional V-belts) which never needs adjustment.

4.3 Liter Vortec V6.

The most powerful V6 available in a compact pickup, the Vortec V6 pumps out 160 SAE net horsepower at 4000 RPM and a whopping 230 lb/ft SAE net torque at 2800 RPM (estimated). That means power to spare for highway driving, trailer towing or



off-road adventuring. It's the standard engine for Sonoma 4x4 models and is available for all 4x2 models, except the Sonoma "Special" model.

2.8 Liter V6. This popular V6 provides lively performance for personal transportation or tough commercial jobs. Available for 4x2 models (except the "Special" Pickup) with the standard 5-speed manual transmission, it delivers 125 SAE net horsepower at 4800 RPM and 150 lb/ft SAE net torque at 2400 RPM (estimated).

2.5 Liter Tech IV. Extensive improvements make this advanced in-line 4-cylinder engine a better-than-ever performer for '91. Thanks to features like fast-burn combustion chambers and 8.3-to-1

compression ratio, it develops 105 SAE net horsepower at 4800 RPM and 135 lb/ft SAE net torque at 3200 RPM (estimated). It's the standard engine for all 4x2 models.

Select your power team. For availability of Sonoma engine/transmission combinations, see the Technical Information chart on page 19.

ENGINE TECHNICAL DATA

TYPE	GASOLINE		
	2.5	2.8	4.3
Displacement, liter (cu in)	2.5 (151)	2.8 (173)	4.3 (262)
Configuration	L4	V6	V6
Ordering code	L38	LL2	LB4
Bore and stroke, in	4.0 x 3.0	3.50 x 2.99	4.0 x 3.48
Compression ratio	8.3 to 1	8.5 to 1	9.3 to 1
Fuel delivery	electronic fuel injection		
SAE net horsepower @ rpm	105 @ 4800	125 @ 4800	160 @ 4000
	(above ratings are estimated)		
SAE net torque (lb/ft) @ rpm	135 @ 3200	150 @ 2400	230 @ 2800
	(above ratings are estimated)		

CHOOSE YOUR LEVEL OF GOOD LOOKS

SLE



UNMISTAKABLY THE TOP OF THE LINE. SLE elegance can be enhanced with your choice of nine available Conventional Two-Tone combinations (ZY2), as shown, each with Steel Gray Metallic as the lower accent color extending around the entire vehicle. Or choose any of the 10 standard solid exterior colors shown on this page.

SLS



A SPECIAL FLAIR FOR BOLDNESS. The sporty SLS styling treatment includes red decal body striping, body-color front bumper with decal stripe and body-color grille. SLS also sets itself apart with five selected exterior solid colors. Choose from Midnight Black, Apple Red, Frost White, Aspen Blue Metallic or Seafoam Green.

SL



SMART, CLEAN AND CONTEMPORARY. Standard SL trim looks good for work or play. It can be ordered in any of the 10 solid exterior colors shown on this page. Or choose one of the available Special Two-Tone combinations (ZY3), as shown, which includes beltline striping in a contrasting color plus a chromed front bumper with bright-trimmed rub strip.

EXTERIOR COLORS

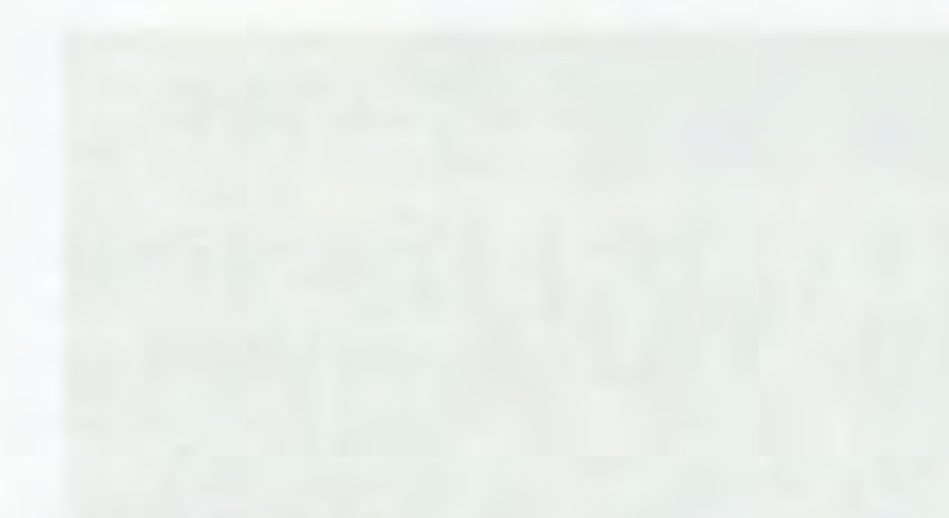

Frost White



Midnight Black



Aspen Blue Metallic



Light Blue

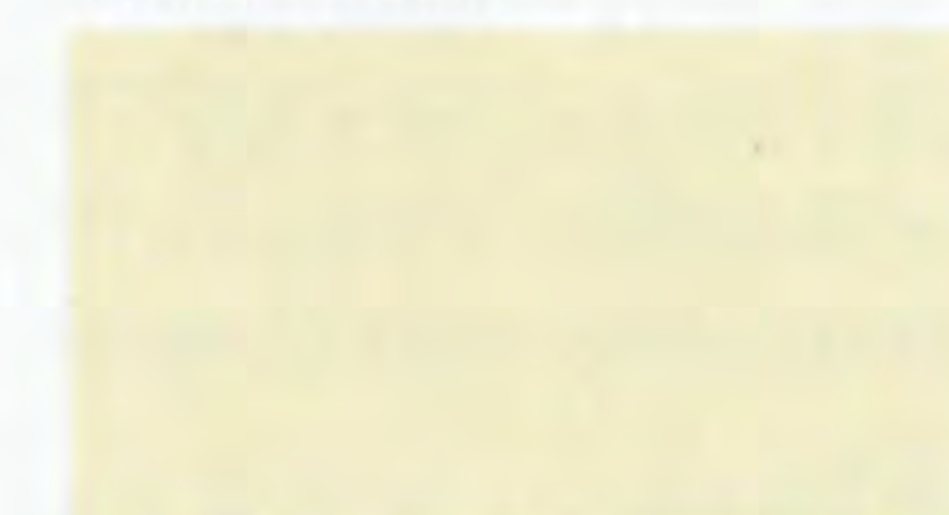

Wheat

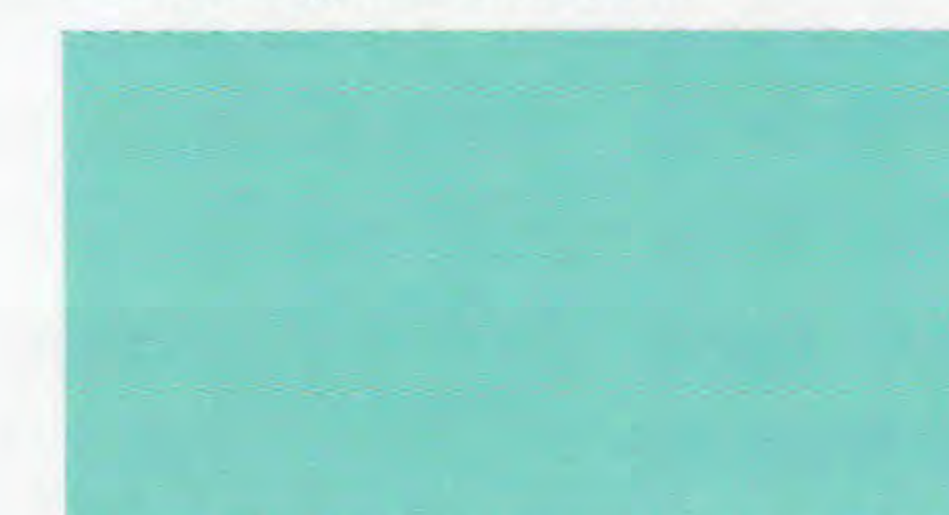

Seafoam Green



Royal Blue Metallic



Garnet

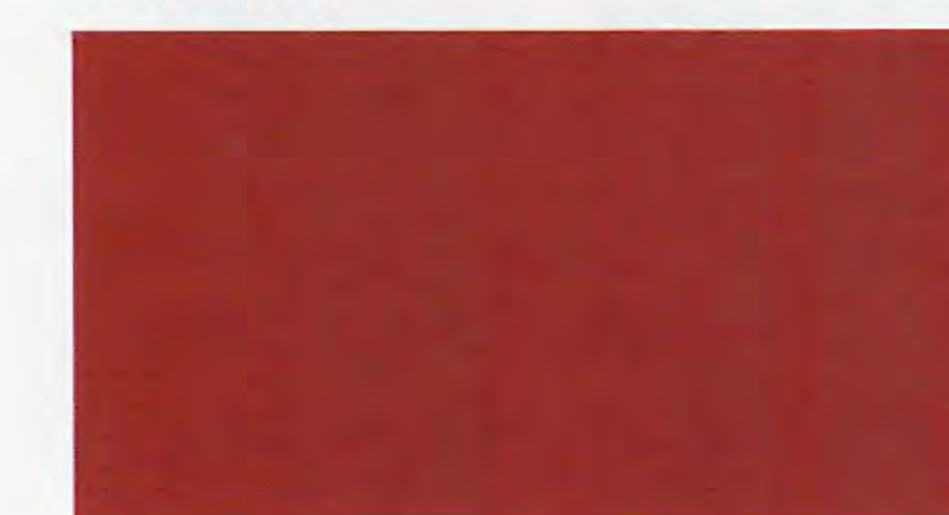

Apple Red



Steel Gray Metallic



Silver Metallic
(two-tone accent color only)

Note: Due to printing irregularities, colors shown may vary slightly from actual tones. Ask your dealer to show you actual paint chips.

EXTERIOR-INTERIOR COLOR COMPATIBILITY

EXTERIOR SOLID COLORS	RECOMMENDED INTERIOR TRIM COLORS			
	BLUE	GARNET	CHARCOAL	SADDLE
Frost White	0	0	0	0
Midnight Black		0	0	0
Aspen Blue Metallic	0		0	
Light Blue	0			
Wheat			0	0
Seafoam Green			0	
Royal Blue Metallic	0		0	
Garnet		0	0	
Apple Red		0	0	
Steel Gray Metallic		0	0	

WORLD CLASS QUALITY

BUILT TO DELIVER SOLID PERFORMANCE AND RELIABILITY.

Good looks aside, Sonoma is a tough-and-ready pickup that can work hard, play hard and keep on coming back for more. From rugged chassis to gleaming finish paint it's engineered and manufactured to meet the highest standards of quality.

The quality begins with computerized design technology and continues through robotic welding and painting procedures to produce a vehicle of outstanding appearance, comfort and strength. You can see excellence in the precise metal-to-metal fits, and you can feel it in the smooth, comfortable ride and acceleration.

You can also feel confident about Sonoma quality, because it's backed by GM's outstanding warranty coverage. See page 19 for details of the limited warranty.

Some of the many quality features are described on these pages. Others are listed in the charts on pages 17 and 19.

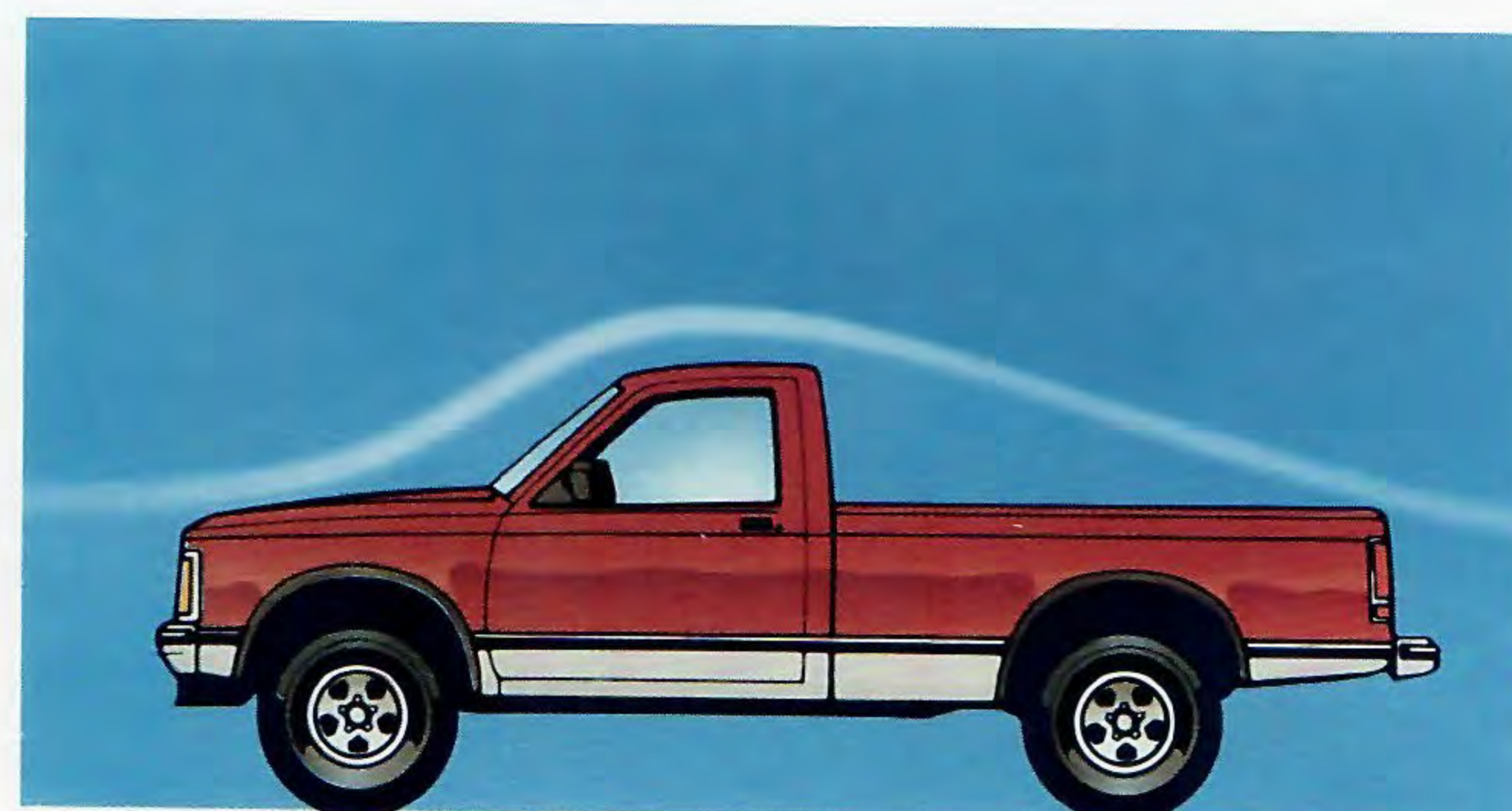

AERODYNAMIC BODY STYLING

provides a low air-drag coefficient which contributes to high operating efficiency. Here are some examples of EPA fuel economy estimates for a '91 4x2 Sonoma Pickup:

EPA ESTIMATES

ENGINE/TRANSMISSION	HWY MPG	CITY MPG
Available 2.8L V6/Standard 5-Spd Manual OD	25	19
Available 4.3L Vortec V6/Available 4-Spd Auto OD	24	18
Available 4.3L Vortec V6/Standard 5-Spd Manual OD	23	17



TWO-STAGE MULTILEAF REAR SPRINGS

help deliver an impressive ride on city streets or back-country roads. These springs are designed to adjust their stiffness to the load, providing a soft ride when the vehicle is empty and firm support when fully loaded. The use of a new anti-corrosion coating and galvanized leaf spacers adds to spring durability for '91. Ride quality is enhanced by revised spring rates and new plastic tip liners for reduced inner leaf friction. One-inch hydraulic shocks add to riding comfort.

INSTA-TRAC 4x4 SYSTEM

provides immediate 4-wheel traction to pull through snow, mud or sand, or to keep you moving on roads slick with rain or ice. Insta-Trac allows the driver to shift between 2-WHEEL and 4-HIGH and back again without stopping or slowing down. It delivers 4-wheel drive at any speed, in any situation where extra traction is needed. A lighted display on the shift console indicates your driving mode, as shown.



REAR WHEEL ANTI-LOCK BRAKE SYSTEM

is an extra-value standard feature on all Sonoma models. This computer-controlled power brake system is designed to provide smooth, stable stops, with the vehicle empty or loaded, on slick or dry pavement. On 4x4 models, this system operates only in the 2-WD mode.



BIG 20-GALLON FUEL TANK allows plenty of miles between fill-ups, a handy plus for pleasure trips or business driving. It's standard on all Sonoma models, except the X81 "Special" where it's available as part of an option package. Sonoma 4x4 models can be ordered with an available shield package which includes fuel tank shielding.

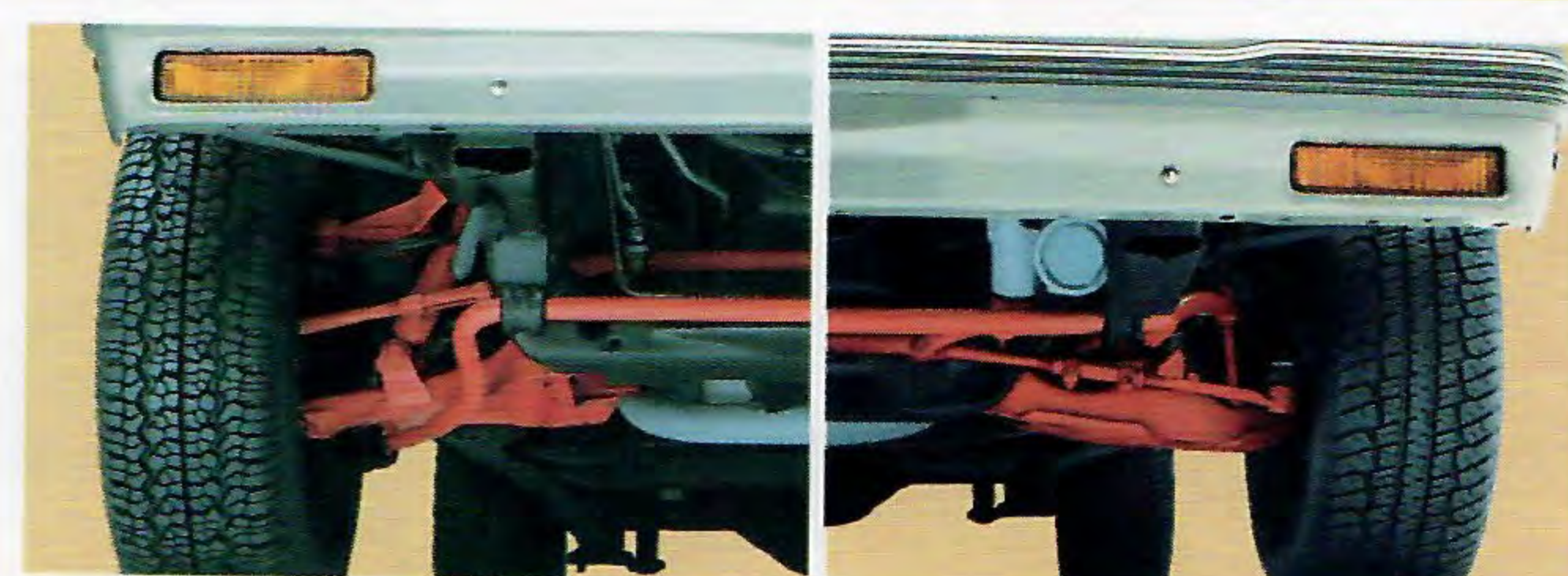

INDEPENDENT FRONT SUSPENSIONS allow each front wheel to work independently of the other for impressive ride control and stability. 4-WD type shown on left and 2-WD type on the right.

CORROSION PROTECTION As part of GM's Bumper to Bumper Plus Warranty (see page 19), Sonoma is protected for 6 years or 100,000 miles against body sheet metal rust-through by one of the most comprehensive anti-corrosion programs in the industry.

This program includes the use of many sheet metal parts which are galvanized on both sides for double protection against rust formation. Another widely used special material is Zincrometal®, a type of steel with a baked-on coating of zinc-rich primer on the side of the steel that becomes the inner surface of the assembled metal part (see chart at right).

Other measures include: A zinc phosphate wash in preparation for painting Total immersion of cab and pickup box bodies, doors and tailgate in Elpo-Dip (an electrically-charged, zinc-rich primer) to assure complete and uniform coverage Anti-chip coating on lower exterior body panels High-solids acrylic enamel finish paint, robotically applied to help assure proper amount and coverage Hot wax coating on frame Special coating on rear springs and axle.

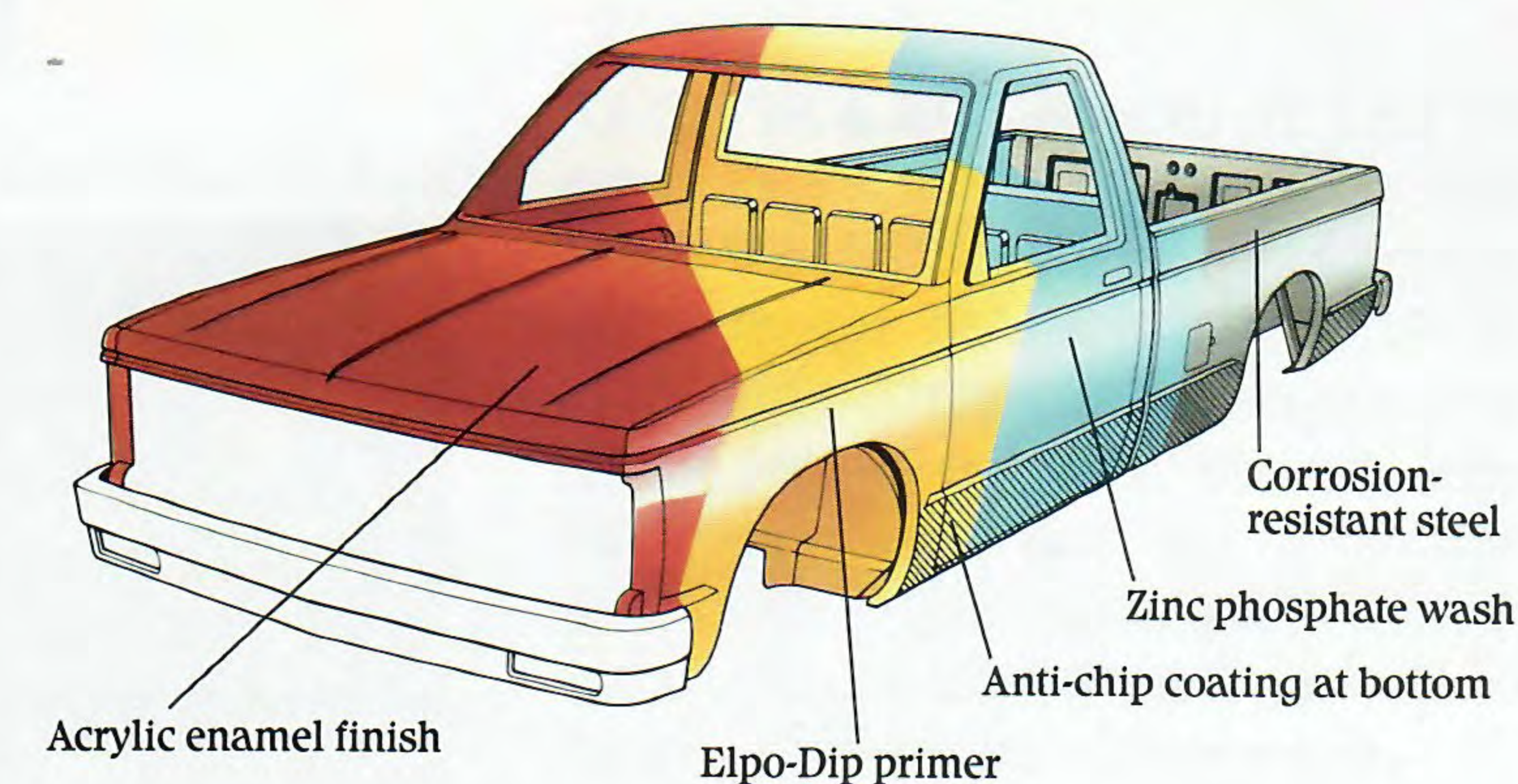

CORROSION-RESISTANT STEEL PARTS IN SONOMA PICKUPS

PART NAME	2-SIDE GALVANIZED	ZINCROMETAL	PART NAME	2-SIDE GALVANIZED	ZINCROMETAL
Hood outer panel		X	Cab rear panel		X
Hood inner panel	X		Side rear quarter panels-outer		X
Fender outer panels		X	Pickup box side inner panels	X	
Fender inner panels		X	Pickup box floor panel	X	
Front wheel-housings	X		Pickup box tailgate		X
Radiator support-lower	X		Wheelhouse inner panels	X	
Windshield frame & plenum panel		X	Pickup box corner supports	X	
Cowl vent panel	X		Door outer panels		X
Door opening frames	X		Door inner panels	X	
Floor & toe panel	X				

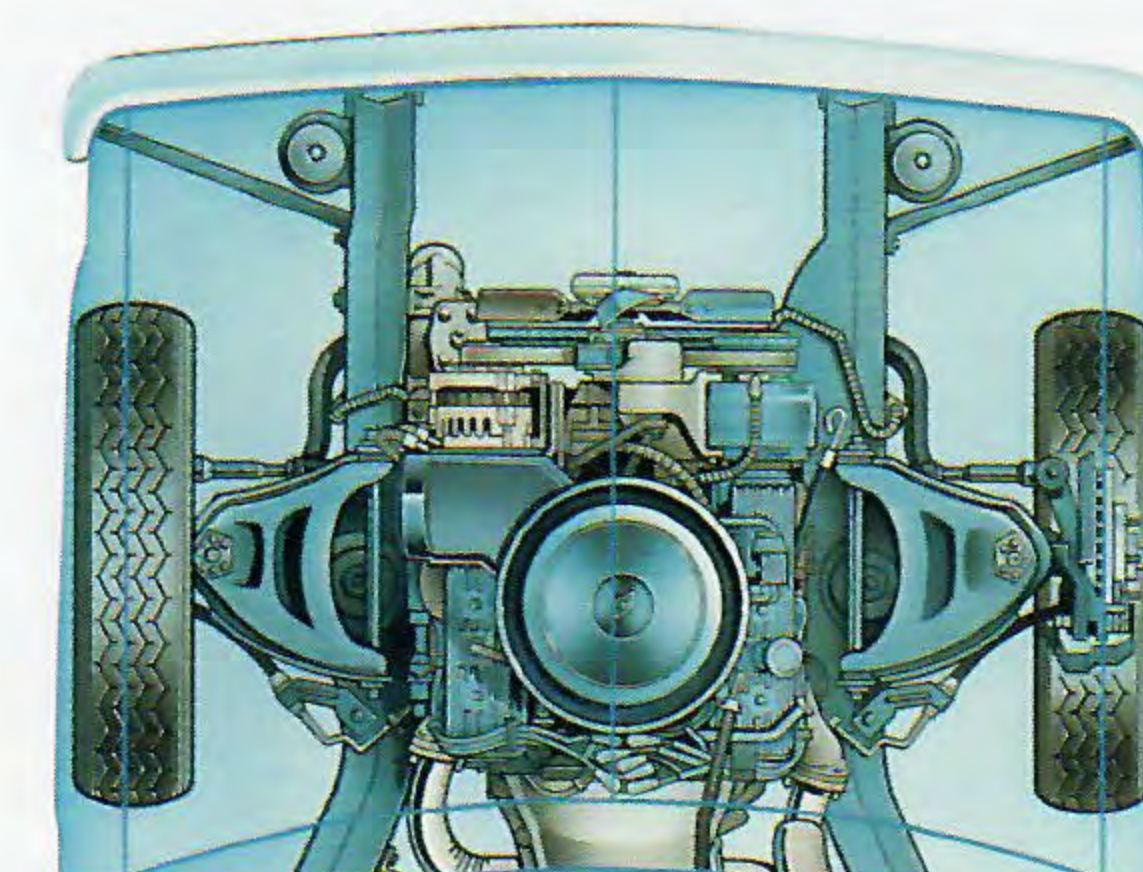

BOX-SHAPED FRONT FRAME SECTION

adds extra rigidity to the chassis front end to help take suspension punishment while supporting the weight of the engine and transmission. Aft of the front section, the frame is of rugged C-channel construction to provide a solid foundation for every Sonoma Pickup.

CLEAN, SIMPLE UNDERHOOD LAYOUT

makes it easy to perform routine service chores. If you like to do things yourself, you'll appreciate the careful design and sensible arrangement of components inside the spacious engine compartment. The oil dipstick is conveniently located. See-through plastic reservoirs



permit quick checks of engine coolant, windshield washer fluid and brake fluid. A built-in hydrometer indicates battery charge condition at a glance.

DOUBLE-WALL STEEL CONSTRUCTION

adds strength and rigidity to Sonoma's cargo box sides and tailgate, hood, front fenders, side doors and part of the cab back panel. The same type of rugged construction is used in GMC Truck full-size pickups. Sonoma quality goes deep with one-piece metal fabrication. Single stampings of major body panels help assure rigidity, accuracy of fit and elimination of leaks. One-piece door frames plus welded-on door hinges provide good fit, alignment and sealing of doors.

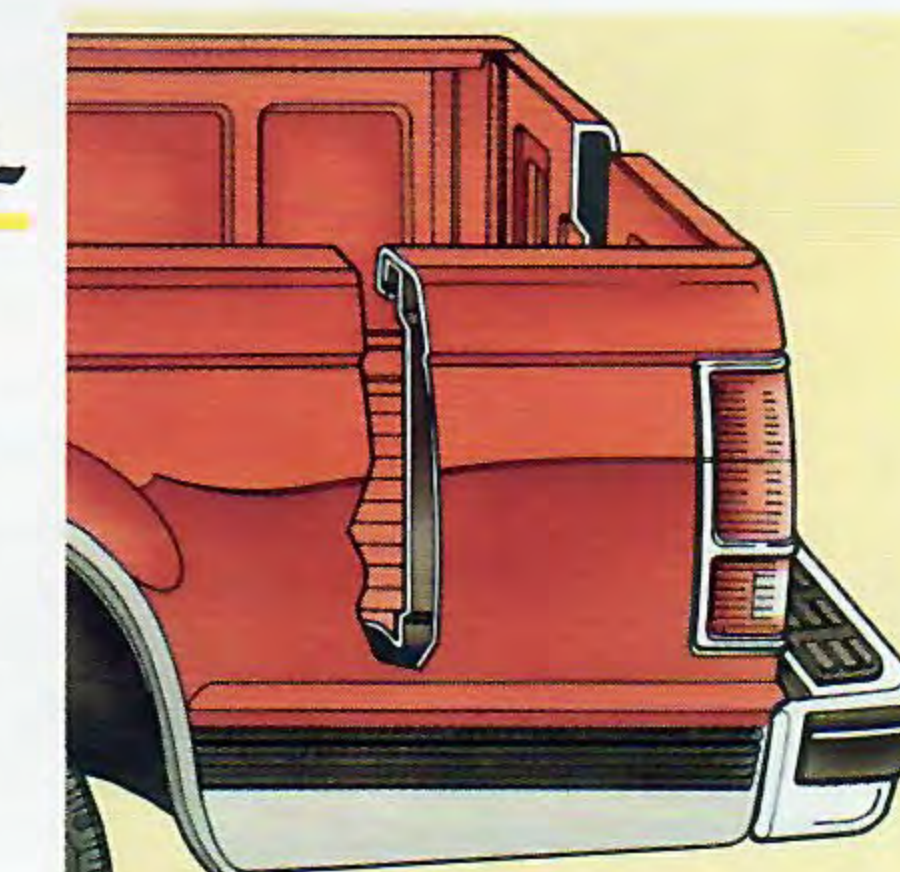

CONVENIENT CRANK-DOWN CARRIER

stores the spare wheel and tire under the rear of the truck. All Sonoma models come equipped with a full-size spare wheel and tire except the X81 "Special" Pickup where they are available as part of an option package. Steel-belted, radial-ply All Season tires are standard. Designed for impressive traction and low rolling resistance, these quality tires eliminate the need for snow tires in many northern localities.



POPULAR SONOMA

EXTRA TOUCHES FOR A SPECIAL DRIVING EXPERIENCE. Sonoma offers a wide range of available equipment for added appearance, performance, comfort and convenience. In addition to the items described on this page, you can choose from many more, including:

- Power steering (4x2 Regular Cab)
- Heavy-duty front/rear shock absorbers
- Heavy-duty rear springs
- Locking differential
- 4x4 underbody shield package
- Heavy-duty battery
- Heavy-duty radiator
- Cold Climate package
- 4x2 sport suspension
- 4x4 suspension package.

Electronic speed control



Electronic instrumentation: tachometer and gauges with vacuum fluorescent displays (available with V6 engine only)

Air conditioning

Delco AM/FM stereo radio with cassette tape player



Short-wheelbase Sonoma SLS with A1A4 EZ-Spec Package



Short-wheelbase Sonoma SLE with A1A6 EZ-Spec Package

REGULAR CAB PACKAGE CONTENT	TRIM LEVEL						
	SL BASE	SLS SPORT	SLE COMFORT				
EZ-Spec Group 1							
SL Base Decor Package	X	X	N/A	N/A	N/A	N/A	N/A
Model Option X96 (Regular Pickup)	X	X	X	X	X	X	X
Wideside Pickup Box	X	X	X	X	X	X	X
EZ-Spec Group 2							
Mirrors, Black	X	X	X	N/I	I	I	I
Steering, Power (2WD Only)	X	X	X	X	X	X	X
Rear Bumper	X	X	X	X	X	X	X
Radio: ETR AM/FM Stereo w/Seek-Scan, Cassette and Clock (A)	X	X	X	N/A	X	N/A	N/A
EZ-Spec Group 3							
SLS Sport Decor Package		X	X	X	N/A	N/A	N/A
Deep Tinted Windows		X	X	N/I	X	X	X
Tires: P205/75R14 W/L (2WD) (A)		X	X	N/I	N/I	N/A	N/A
Tires: P205/75R15 W/L (4WD) (A)		X	X	N/I	N/I	N/A	N/A
Tilt Wheel & Intermittent Wipers		X	X	N/I	N/I	X	X
EZ-Spec Group 4							
Air Conditioning		X	N/I	N/I	X	X	X
Cruise Control, Electronic		X	N/I	N/I	X	X	X
EZ-Spec Group 5 (2WD Only)							
Suspension, Sport				X	N/I	X	X
Tires: P215/65R15 W/L (2WD Only)				X	X	X	X
Engine: 4.3 Liter Vortec V6				X	N/I	N/I	N/I
Springs: Rear, Heavy-Duty				X	N/I	X	X
Radio: ETR AM Stereo/FM Stereo w/Seek-Scan, Cassette, Graphic Equalizer and Clock				X	N/I	X	X
EZ-Spec Group 6							
SLE Comfort Decor Package					X	X	X
Tires: P235/75R15 W/L (4WD Only)					X	X	X
EZ-Spec Group 7							
Lighting Auxiliary						X	X
Shield Package (4WD Only)						X	X
Suspension Package (4WD Only)						X	X
Suspension, Sport (2WD Only)						X	X

A - Upgrade allowed. See your dealer for details.
X - Included in EZ-Spec Package.

N/A - Not available.
I - Included with another option.

N/I - Not included.

QUICK ORDER EZ-SPECS

For product selection convenience, buy a Sonoma Regular Cab Pickup with one of the available Quick Order EZ-Spec Packages shown in the adjacent chart. Similar packages exist for other Sonoma Pickups; see your dealer for details. All packages include carefully selected equipment which our experience reveals to be the most desirable to prospective buyers.

AVAILABLE EQUIPMENT

EXTERIOR EQUIPMENT (1)

MODEL	REGULAR CAB			CLUB COUPE			MODEL	REGULAR CAB			CLUB COUPE			
	SL (STD)	SLS (YC1)	SLE (YC2)	SL (STD)	SLS (YC1)	SLE (YC2)		SL (STD)	SLS (YC1)	SLE (YC2)	SL (STD)	SLS (YC1)	SLE (YC2)	
AIR DAM WITH FOG LAMPS							IDENTIFICATION, TAILGATE	Sonoma/GMC applique	S			S		
BUMPER, FRONT	4x2 models	A	A	A	A	A	Sonoma ST decal at lower left		S			S		
	Painted (gray)	S			S		Sonoma/GMC applique			S			S	
	Painted (body color)		S			S	4.3 Fuel Injection nameplate at upper right (LB4 engine)	A 9	A 9	A 9	A 9	A 9	A 9	
	Painted (gray) with bright-trimmed rub strip			S		S	KEY CYLINDERS	Black finish	S	S	S	S	S	
	Chromed with bright-trimmed rub strip	A 2			A 2		MIRRORS	Dual outside, conventional - black	S	S		S	S	
BUMPER, REAR STEP-TYPE	Painted (gray) with step pad	A			A			Dual outside, below eyeline - black	A	A	S	A	S	
	Painted (body color) with step pad		A			A		Dual outside, electric remote-controlled-black	A	A	A	A	A	
	Painted (gray) with bright-trimmed rub strips and step pad			A		A	MOLDINGS	Body side - gray with bright trim			S		S	
	Chromed with bright-trimmed rub strips and step pad	A 3			A 3			Wheel opening - bright	A	A	S	A	A	
CARRIER, WINCH-TYPE FULL-SIZE SPARE TIRE		S	S	S	S	S		Wheel opening - black	A	A	A	A	A	
DOOR HANDLES	Black finish	S	S	S	S	S	PAINT/STRIPING	Windshield - black	S	S	S	S	S	
GLASS	Windshield and door, tinted	S	S	S	S	S		Solid paint in choice of 10 colors	S 5		S 5	S 5		
	Fixed rear window, tinted	S	S	S	S	S		Special 2-tone paint, using 10 primary colors; includes body striping at beltline	A			A		
	Sliding rear window, tinted	A	A	A	A	A		Solid paint in choice of 5 colors; includes red lower body and front bumper striping		S			S	
	Fixed quarter windows, tinted				S			Conventional 2-tone paint, using 9 primary colors and Steel Gray Metallic as secondary color			A		A	
	Swing-out quarter windows, tinted				S	S		Pop-up type with deep-tinted glass	A	A	A 6	A	A	
	Deep-tinted glass for standard rear window	A	A	A				Black		S			S	
	Deep-tinted glass for standard rear window and quarter windows				A 4	A		Bright			S		S	
GRILLE WITH INTEGRAL HEADLAMP/SIDE MARKER LAMP BEZELS	Charcoal painted main body; dark gray air intake area with bright-outlined red GMC letters	S			S			WHEELS/WHEEL TRIM, 4x2 MODELS	Conventional disc: Gray with bright hubcaps	S 7			S 7	
	Body color painted main body; dark gray air intake area with bright-outlined red GMC letters		S			S			Styled: Gray with red striping and gray hub ornaments		S			S
	Chromed main body; dark gray air intake area with bright-outlined red GMC letters			S		S			Rally: Gray with gray hub ornaments and bright trim rings	A		S	A	
HEADLAMPS	Halogen-type	S	S	S	S	S		WHEELS/WHEEL TRIM, 4x4 MODELS	14-hole disc: Gray with gray hub ornaments	S 7	S 7		S 7	S 7
HOOKS, FRONT TOW	4x4 models	S	S	S	S	S			14-hole disc: Gray with gray hub ornaments and bright trim rings			S		S
HORN	Single electric high-note	S	S	S	S	S			Cast aluminum (gray paint finish with black paint trim)	A	A	A	A	A
IDENTIFICATION, SIDE	GMC/Sonoma nameplate on door at lower front	S		S	S				Conventional	S	S	S	S	S
	Sonoma ST decal on door at lower front		S			S			Intermittent	A 8	A 8	A 8	A 8	A 8
	SL nameplate on B-pillar	S			S									
	SLE nameplate on B-pillar			S		S								
	4x4 decal on pickup box at upper rear (4x4 models)	S	S	S	S	S								

S - Standard
A - Available

1 - Except X81 "Special" model.
2 - Part of ZY3 Special Two-Tone Paint.

3 - With ZY3 Special Two-Tone Paint only.
4 - Includes swing-out quarter windows.
5 - D96 Body Beltline Striping available.

6 - Requires A28 Sliding Rear Window.
7 - P06 Wheel Trim Rings (bright) available.

8 - Part of ZM7 Driver Convenience Package.
9 - Standard on 4x4 models.

INTERIOR EQUIPMENT (1)

MODEL	REGULAR CAB			CLUB COUPE			MODEL	REGULAR CAB			CLUB COUPE		
	SL (STD)	SLS (YC1)	SLE (YC2)	SL (STD)	SLS (YC1)	SLE (YC2)		SL (STD)	SLS (YC1)	SLE (YC2)	SL (STD)	SLS (YC1)	SLE (YC2)
TRIM LEVEL							TRIM LEVEL						
AIR CONDITIONING		A	A	A	A	A	LAMP SWITCHES, DOME & COURTESY	Front door	S	S	S	S	S
ARMRESTS	Front door	S	S	S	S	S	Main light	S	S	S	S	S	
CLOCK, ELECTRIC DIGITAL		S 2	S 2	S 2	S 2	S 2	LIGHTER, CIGARETTE		S	S	S	S	
COAT HOOK	Right hand	S	S	S	S	S	MIRRORS	Day/night rearview, conventional	S	S	S	S	
	Left hand				S	S		Day/night rearview with dual reading lamps	A 6	A 6	A 6	A 6	
COLD CLIMATE PACKAGE		A	A	A	A	A		RH visor, unlighted		S	S		
CONSOLE, FLOOR-MOUNTED STORAGE		A 3	A 3	A 3	A 3	A 3		LH & RH visor, lighted	A	A	A	A	
CONVENIENCE GROUPS	Intermittent windshield wiper/tilt steering wheel combination	A	A	A	A	A	NAMEPLATE, TRIM LEVEL - INSTRUMENT PANEL		S	S	S	S	
	Power door lock/power window combination	A	A	A	A	A	RADIOS, ELECTRONICALLY TUNED	AM/FM stereo (7)	S	S	S	S	
CONVENIENCE TRAY		S	S	S	S	S		AM/FM stereo with cassette tape player (7)	A	A	A	A	
FLOOR COVERING, FIXED	Black rubber, partial floor	S						AM stereo/FM stereo with graphic equalizer and stereo cassette tape player with search-repeat (7)	A	A	A	A	
	Charcoal vinyl-coated rubber, full floor		A 9		S	A 9	SEATS	Folding back front bench	S	S	S	S	
	Color-keyed carpet, full floor	A	S	S 4	A	S 4		High-back front bucket, LH & RH	A	A	A	A	
FLOOR MATS, FRONT REMOVABLE			A	S		A		Rear jump, LH & RH				A	
FLOW-THROUGH POWER VENTILATION		S	S	S	S	S	SEAT BACK, BUCKET	Folding feature	S	S	S	S	
GRAB HANDLE	Over RH front door	S 5	S 5	S 5	S 5	S 5		E-Z entry feature (RH seat)				S	
HEADLAMP WARNING BUZZER		A 6	S	S	A 6	S		Reclining feature				S	
HEADLINER	Partial coverage	S					STEERING WHEEL	Standard, black	S 8			S 8	
	Full coverage		S	S	S	S		Deluxe, black	S 5	S	S 5	S	
HEATER & DEFOGGER, DELUXE		S	S	S	S	S	STORAGE COMPARTMENT WITH LOCK		S	S	S	S	
INSTRUMENT CLUSTER	Gage-type with trip odometer	S	S	S	S	S	SUNSHADES, LEFT/RIGHT HAND		S	S	S	S	
	Electronic gage-type with trip odometer and tachometer (available with V6 engine only)	A	A	A	A	A	TRIM PANELS, DOOR - COLOR - KEYPED PLASTIC	With map pockets	S	S		S	
KEY-IN-IGNITION WARNING BUZZER		S	S	S	S	S		With map pockets, cloth inserts, carpet trim & LH coin holder			S		
LAMPS	Front dome	S	S	S	S	S	TRIM PANELS, REAR COMPARTMENT	Upper				S	
	Courtesy, LH/RH	S	S	S	S	S		Lower (with storage pockets)				S	
	Ashtray	A 6	S	S	A 6	S							
	Glove box	A 6	S	S	A 6	S							
	Engine compartment	A 6	A 6	A 6	A 6	A 6							

S - Standard
A - Available

1 - Except X81 "Special" model.
2 - Included with standard radio.
3 - Requires available bucket seats.

4 - Includes cab back panel.
5 - 4x4 models only.
6 - Part of TR9 Auxiliary Lighting.

7 - Also includes seek-scan, digital clock, premium dual rear speakers and mast-type antenna. Radio delete option available.

8 - 4x2 models only.
9 - Deletes standard carpeting.

MODEL SELECTOR

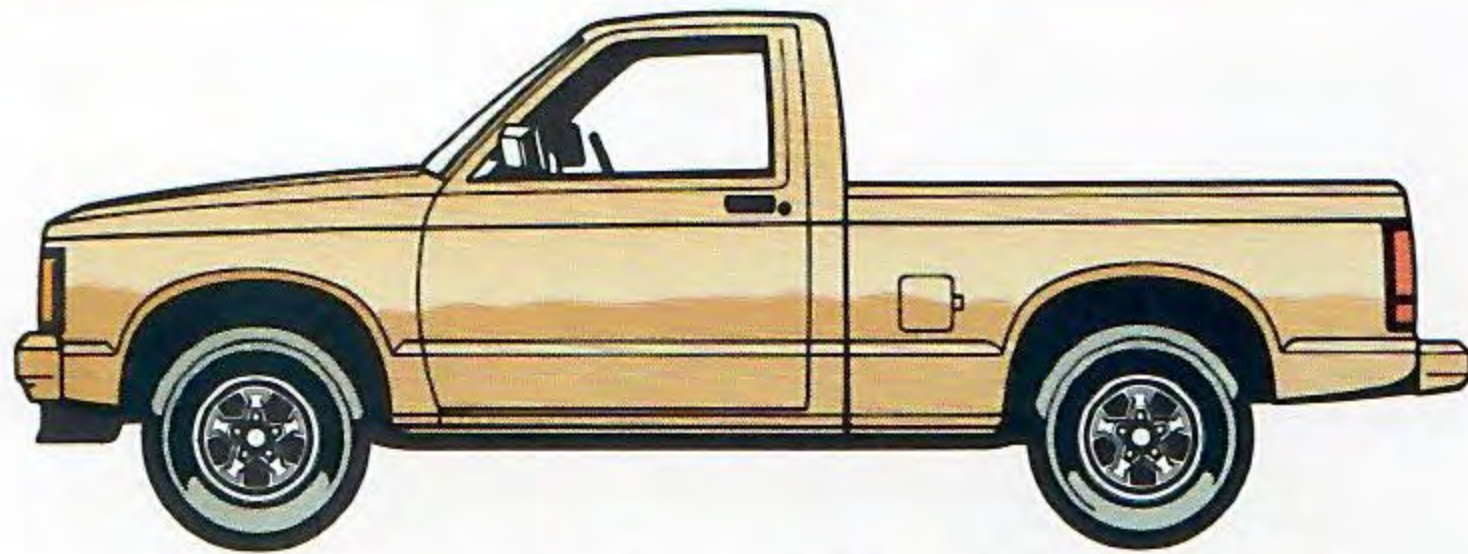
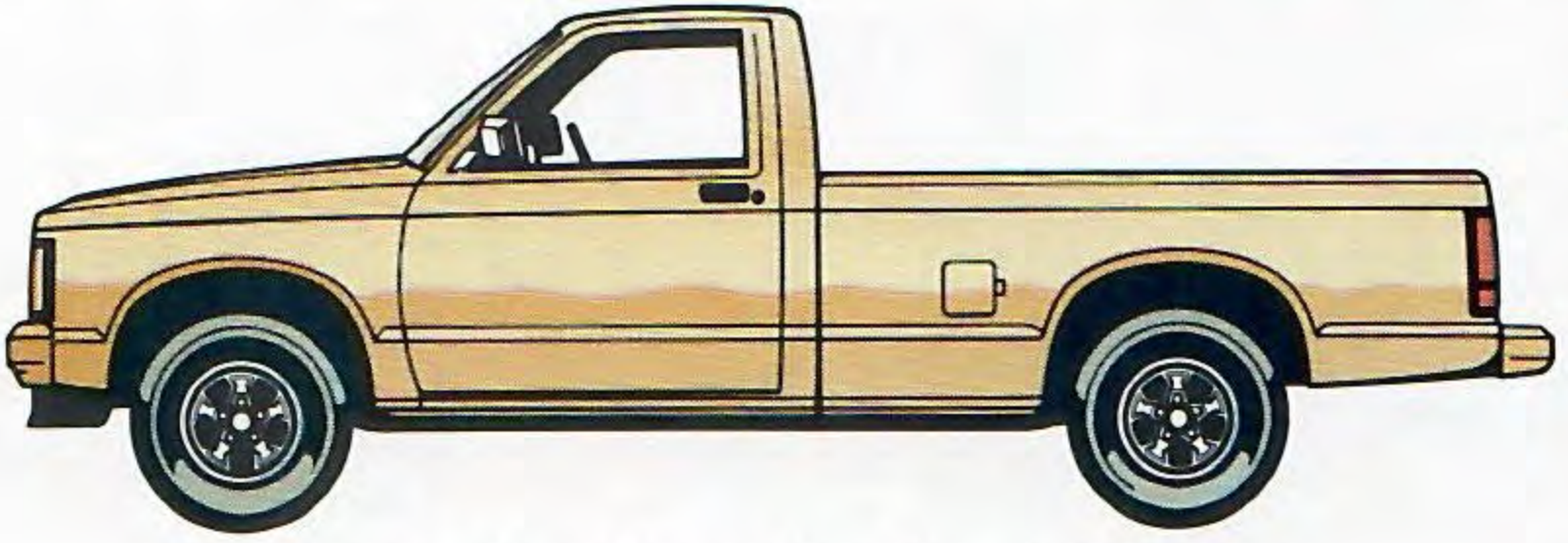
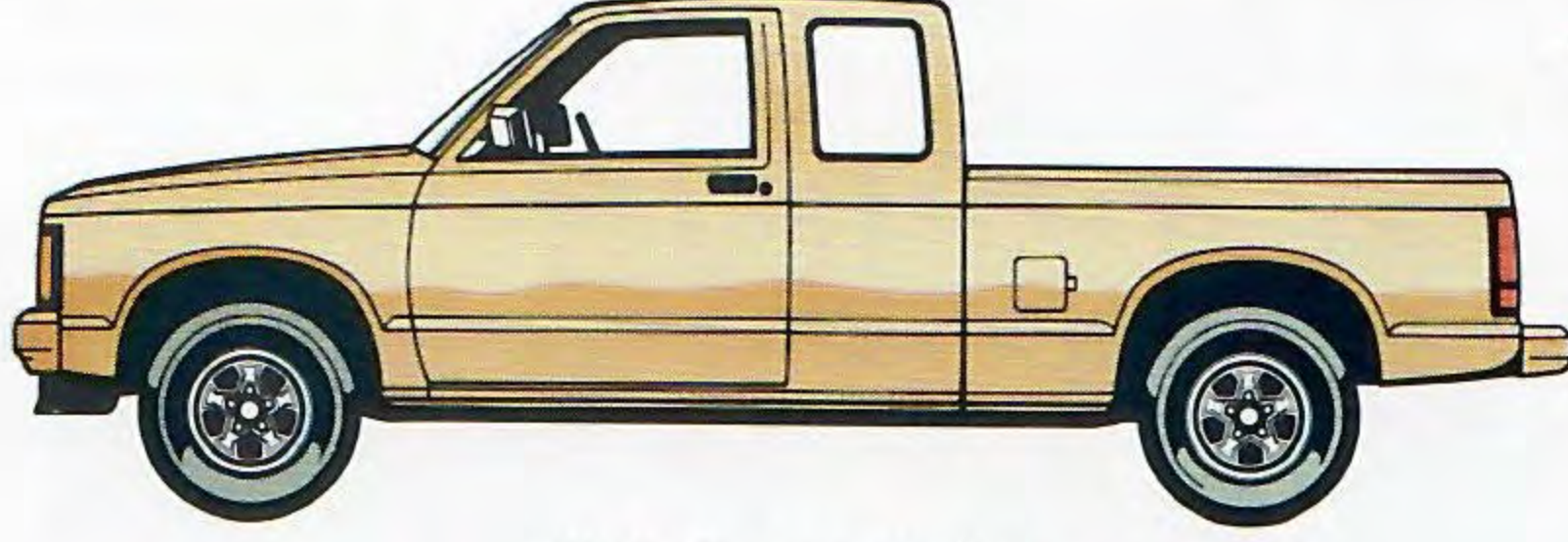
PICKUP TYPE	MODEL NUMBER	DRIVE TYPE	GVWR (lb)	CARGO BOX LENGTH (ft)
	TS10603 (1)	2-wheel	4200	6.1
	TS10603 (4)	2-wheel	4200/4600	6.1
	TT10603	4-wheel	4650/5150	6.1
	TS10803	2-wheel	4200/4600/4900	7.4
	TT10803	4-wheel	4650/5150	7.4
	TS10653	2-wheel	4200/4600	6.1
	TT10653	4-wheel	4650/5150	6.1

GVWR - Gross Vehicle Weight Rating

1 - X81 "Special" Pickup.

2 - X96 Regular Pickup.

EXTERIOR DIMENSIONS*

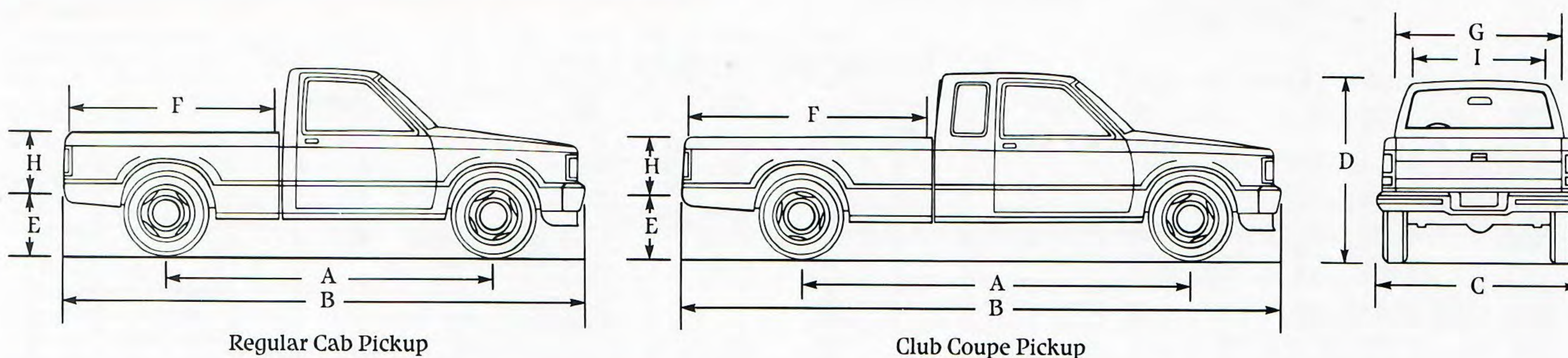

PICKUP CAB TYPE	REGULAR CAB		CLUB COUPE	
	2-WD	4-WD	2-WD	4-WD
Drive type	2-WD	4-WD	2-WD	4-WD
A-Wheelbase	108.3/117.9	108.3/117.9	122.9	122.9
B-Overall length**	178.2/194.2	178.2/194.2	192.8	192.8
C-Overall width	64.7	64.7	64.7	64.7
D-Overall height	61.6/61.3	63.6/63.5	61.3	63.4
E-Loading height	28.3/28.1	29.6/29.5	28.0	29.3
F-Cargo box length	73.1/89.0	73.1/89.0	73.1	73.1
G-Cargo box width	59.1	59.1	59.1	59.1
H-Cargo box depth	15.8	15.8	15.8	15.8
I-Width between wheelhousings	40.3	40.3	40.3	40.3

*All dimensions are inches.

**Does not include optional rear bumper.

TECHNICAL INFORMATION

DRIVE TYPE	2-WHEEL		4-WHEEL		
GVW RATING, lb	4200	4600	4900 (10)	4650	5150
ESTIMATED PAYLOAD RANGE, lb	1190-1445	1580-1915	1915	1285-1410	1775-1900
ENGINE/TRANSMISSION AVAILABILITY	(consult your GMC Truck dealer for available axle ratios)				
2.5L L4/5-speed manual overdrive	standard	standard	—	—	—
2.5L L4/4-speed automatic overdrive	available (1)	available	—	—	—
2.8L V6/5-speed manual overdrive	available (1)	available	—	—	—
4.3L V6/5-speed manual overdrive	available (1)	available (2)	available	standard	standard
4.3L V6/4-speed automatic overdrive	available (1)	available (2)	available	available	available
FRONT SUSPENSION	independent, coil springs (3)		independent, torsion bars (4)		
Capacity, lb	2500	2500	2500	2700	2700
Spring/torsion bar capacity at grd (ea), lb	1250	1250	1250	1350 (6)	1350 (6)
Shock absorber diameter, in	—	—	standard: 1.00; available: 1.26	—	—
Stabilizer bar diameter, in	1.00	1.00	1.00	1.10	1.10
REAR SUSPENSION	Salisbury axle, leaf springs				
Axle capacity, lb	2300	2700	2700	2300	2700
Spring capacity at grd (ea), lb	1150	1350	1350	1150	1350
Shock absorber diameter, in	—	—	standard: 1.00; available: 1.26	—	—
BRAKES	hydraulic; front disc/rear drum with rear wheel anti-lock system (11)				
Vacuum booster	standard				
Parking	cable to rear wheels				
STEERING	recirculating ball gear, parallelogram linkage				
Standard	manual (5)	manual (5)	manual (5)	power	power
Available	power (1) (7)	power (7)	power (7)	—	—
TIRES	steel-belted; radial-ply; blackwall; front, rear and spare				
Standard (All Season type)	P195/75R-14	P205/75R-14	P205/75R-14	P205/75R-15	P205/75R-15
Available	various (consult your GMC Truck dealer) (8)				
FUEL TANK CAPACITY (gallons)	20 (9)	20	20	20	20
FREEDOM BATTERY CCA	standard: 525; available: 630				
GENERATOR AMPS	96 (2.5L); 85 (2.8L & 4.3L)				

CCA - Cold Cranking Amps

1 - Except X81 "Special" model.

2 - Except Model TS10803

3 - Z08 Sport Suspension available; requirements and inclusions not listed below; see your dealer for details.

4 - ZM6 Suspension Package available; requirements and inclusions not listed below; see your dealer for details.

5 - Except 4x2 Club Coupes.

6 - F60 heavy-duty front torsion bar springs available for front-mounted

accessory usage; includes heavy-duty shock absorbers.

7 - Standard on 4x2 Club Coupes. Required with 4.3L engine on other models.

8 - Tire chains should not be used with available P235/75R-15 on-off road tires as they may cause damage to the vehicle.

9 - 13-gallon tank standard on X81 "Special" model (20-gallon tank available as part of X97 Option Package).

10 - Model TS10803 only.

11 - Operates in 2-WD only.

OWNER BENEFITS

LOW MAINTENANCE

The technology that goes into Sonoma has contributed in many ways to reducing the time and effort required for routine service and maintenance. Consider these advanced features: Delco Freedom II + battery never needs refilling with water and has a built-in test hydrometer Integral solid-state voltage regulator is built into the Delcotron generator Starter solenoid is integral, providing positive starter engagement Large fuse block has tweezer-type fuse remover for easy serviceability Mufflers have heavy-gauge outer shell and are aluminized inside and out for added durability Engine coolant recovery reservoir collects hot overflow coolant and returns it to radiator automatically when it cools Self-adjusting hydraulic clutch with manual transmission Tires have built-in tread wear indicators See-through reservoirs for quick checks of engine coolant, windshield washer fluid and brake fluid No adjustments for idle speed or idle air-fuel mixture; an on-board computer helps tune the engine as you drive Audible wear sensors for front disc brake pads for early warning of brake wear Front and rear brake designs

include a self-adjusting feature, and rear brakes include an anti-lock feature (operates only in 2-WD on 4x4 models) Single-belt engine accessory drive with automatic belt tensioner.

DEALER SERVICE



Commitment Plus is one of the most complete joint sales and service customer satisfaction programs available on trucks today. It offers the following benefits:

- A thorough pre-delivery vehicle inspection
- One full tank of fuel
- Complimentary 3000-mile maintenance service including oil change and oil filter

GMC Truck and GMC Truck Dealerships are truly committed to making GMC Truck models easy to own and drive. Our customers' total satisfaction is indeed our goal! Commitment Plus applies to retail sales only.

FINANCING AND LEASING

GMAC When it comes to financing or leasing a new GM vehicle, General Motors Acceptance Corporation can make things easy.

With GMAC the entire transaction is handled right in the dealer's showroom. Rates are competitive and terms are tailored to fit your circumstances. For many people, leasing a new truck through GMAC is an ideal way to suit their transportation needs. Ask your GMC Truck dealer for details.

VEHICLE WARRANTY

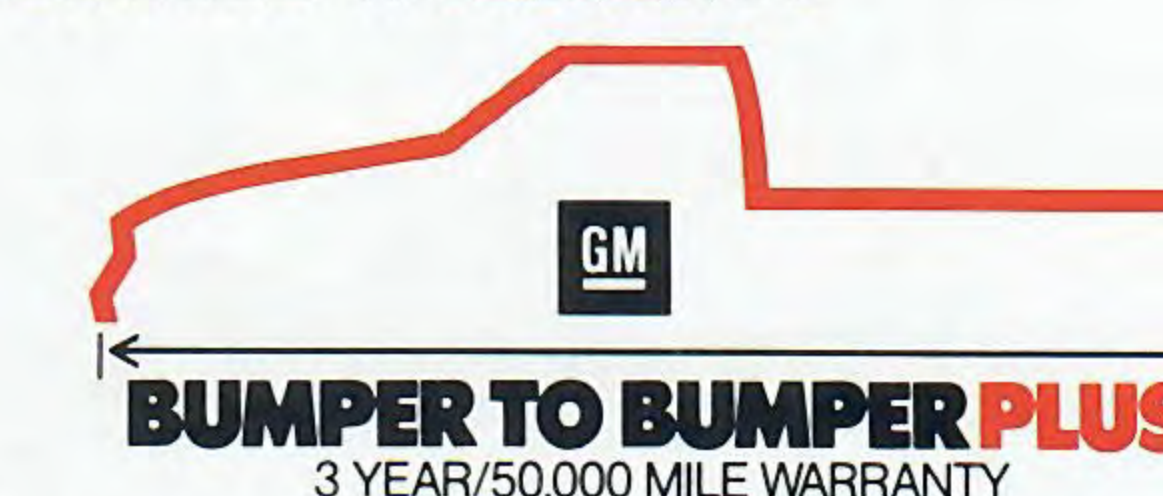

The GM 3-year/50,000-mile BUMPER TO BUMPER PLUS WARRANTY covers repairs for any new GMC Truck model, including labor and parts, to correct any defects in material or workmanship occurring during the warranty period. The complete vehicle (except tires, which are covered by their manufacturer) will be covered for 3 years or 50,000 miles, whichever comes first. After the first year or 12,000 miles, whichever comes first, there is a \$100 deductible per repair visit. Body sheet metal rust-through from corrosion is covered for 6 years or 100,000 miles, whichever comes first. There is no deductible for rust-through repairs. See your GMC Truck dealer for terms of this limited warranty.

1991 GMC TRUCK SAFETY FEATURES

OCCUPANT PROTECTION:

- Manual lap/shoulder safety belts, outboard front seat positions
- Manual lap safety belts, rear seat and center front seat positions
- Energy absorbing steering column
- Energy absorbing instrument panel
- Energy absorbing seat back tops, front
- Interlocking door latches
- Inertia-locking, folding front seat backs
- Safety armrests
- Break-away inside rearview mirror
- Security door locks and door retention components.

ACCIDENT AVOIDANCE:

- Side marker lamps and reflectors
- Parking lamps that illuminate with headlamps
- Four-way hazard warning flashers
- Back-up lamps
- Directional signal control with lane change feature
- Windshield defroster, washer and multi-speed wipers
- Outside left and right rearview mirrors
- Brake system with dual master cylinder and warning light
- Starter safety switch
- Dual action hood latch
- Low glare finish on inside windshield moldings, wiper arms and blades, metallic steering wheel surfaces
- Illuminated heater and defroster controls
- Tires with built-in tread wear indicators
- Rear wheel anti-lock brake system.

IMPORTANT: A WORD ABOUT THIS CATALOG.

We have tried to make this catalog as comprehensive and factual as possible. We reserve the right, however, to make changes at any time, without notice, in prices, colors, materials, equipment, specifications, models and availability. Also, tires shown in illustrations are supplied by various manufacturers. Since some information may have been updated since the time of printing, please check with your GMC Truck dealer for complete details.

A WORD ABOUT ENGINES. GMC Truck models are equipped with engines pro-

duced by the GM Engine Division, its subsidiaries or suppliers to GM worldwide.

A WORD ABOUT ASSEMBLY OF GMC TRUCK MODELS.

GMC Truck models are assembled by different operating units of General Motors, its subsidiaries or suppliers to GM worldwide. GMC Truck models incorporate thousands of components produced by different operating units of GM, its subsidiaries or suppliers to GM worldwide. We sometimes find it necessary to produce GMC Truck models with different or differently sourced components than originally scheduled. All such components have been approved for use in GMC Truck models and will provide the quality performance associated with the GMC Truck name. Since some options may be unavailable when your vehicle is assembled, we suggest you verify that your vehicle includes the equipment you ordered or, if there are changes, that they are acceptable to you.

A WORD ABOUT UPDATED SERVICE INFORMATION.

GMC Truck Division regularly sends its dealers useful service bulletins about GMC Truck products. GMC Truck Division monitors product performance in the field. We then prepare bulletins for servicing our products better. Now you can get these bulletins, too. Ask your dealer. To get ordering information, call toll free 1-800-551-4123.

A WORD ABOUT CORROSION PROTECTION.

GMC Truck models are designed and built to resist corrosion. All body sheet metal components are warranted against rust-through corrosion for 6-years/100,000-miles. See your dealer for details of this limited warranty. Application of additional rust inhibiting materials is not required under the corrosion coverage.

GM®, GMAC®, Vortec®, Insta-Trac® and Delco® are registered trademarks of General Motors Corporation. GMC Truck™, Sonoma™ and Commitment Plus/GMC Truck logo™ are trademarks of General Motors Corporation.

© 1990 General Motors Corporation.
All Rights Reserved.

GMC TRUCK

